

Key stage 3 mathematics 2008

Mental mathematics Test B

First name _____

Last name _____

School _____

Total marks

Practice question

		99	
--	--	----	--

Time: 5 seconds

1		<input type="text"/>
---	--	----------------------

2	4.7, 4.8, 4.9, _____, _____	<input type="text"/>
---	-----------------------------	----------------------

3		$4pq$	<input type="text"/>
---	--	-------	----------------------

4		$\frac{7}{100}$	<input type="text"/>
---	--	-----------------	----------------------

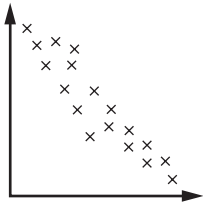
5			<input type="text"/>
	None	Gradient	
	Positive	Negative	<input type="text"/>

Time: 5 seconds continued

6	%	10 out of 25	<input type="text"/>
---	---	--------------	----------------------

Time: 10 seconds

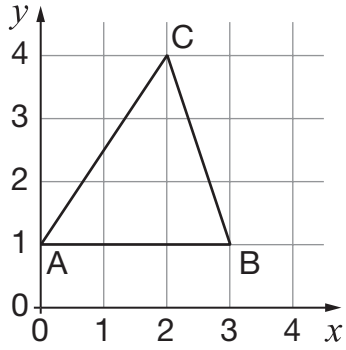
7			<input type="text"/>
	(,)		

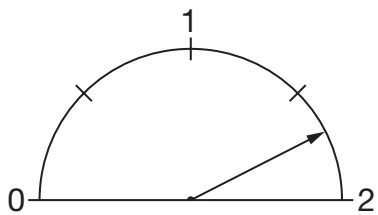
8			<input type="text"/>

9	£	£3.60	<input type="text"/>
---	---	-------	----------------------

10	mm	10cm	<input type="text"/>
----	----	------	----------------------

11		2.9	<input type="text"/>
----	--	-----	----------------------

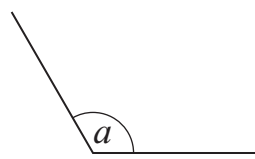
12			<input type="text"/>

13		$\frac{1}{5}$ 2	<input type="text"/>
----	--	-----------------	----------------------

14		148	<input type="text"/>
----	--	-----	----------------------

Time: 10 seconds continued

15

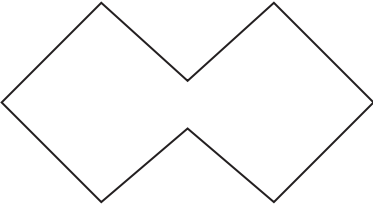

15

16

17 red
13 green

16

17

36

17

18

$21 - 3x = 9$

18

19

2 cm Scale factor 2

cm^2

19

20

$(x + 2)(x - 1)$

20

21

10cm^2 90cm^3

cm

21

Time: 15 seconds

22

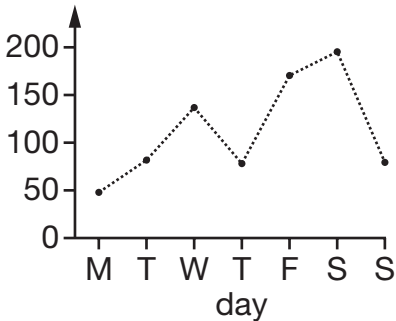

days

22

Time: 15 seconds continued

23

23

24

40p for 5 minutes

£

24

25

$\frac{3}{5}$ $\frac{4}{5}$ $\frac{5}{6}$ $\frac{6}{9}$ $\frac{7}{10}$

25

26

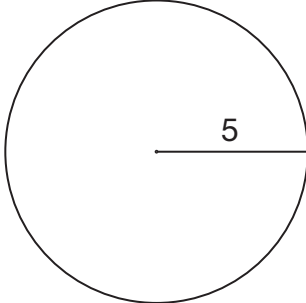

5π 10π 15π
 25π 100π

26

27

£ 1 : 4 : 5

27

28

$\frac{39.92 \times 41.06}{1.98}$

28

29

-20 80 40 _____

29

30

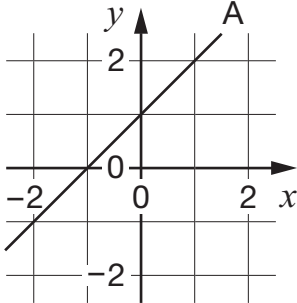

30